

Article number: 20580M20A4
Description: E+G Lifting eye bolts
DIN 580-M20-A4

Measures

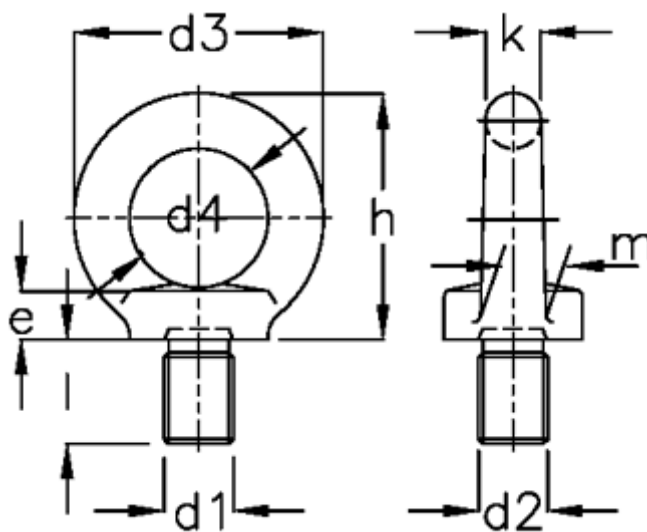

$d1 = M20$	$K = 16$
$d2 = 40$	$l = 30.0$
$d3 = 72$	$m = 19$
$d4 = 40$	
$e = 14$	
$F1 = 12000$	
$F2 = 8300$	
$H = 71$	